



# Evaluation of Power System Reliability Incorporating Protection System Miscoordination

S. Sabzebin<sup>1</sup>, A. Saberi Noghabi<sup>1\*</sup>, K. Mazlumi<sup>2</sup>

<sup>1</sup>Faculty of Electrical and Computer Engineering, University of Birjand, Birjand, Iran

<sup>2</sup>Department of Electrical Engineering, University of Zanjan, Zanjan, Iran

**ABSTRACT:** The operation of protection systems has a considerable impact on power system reliability. The main reason for cascading outages is protection system misoperation. Protection systems affect power system reliability from two perspectives: First, incorrect operation of the protection system due to the failure of any of its components that causes failure to operate or undesired tripping. Second is the incorrect operation of the protection system due to the incorrect setting of relays. In the second case, the protection system is healthy, and incorrect operation is only the result of the erroneous setting of relays. In this paper, an analysis of power system reliability regarding failure and incorrect settings of the protection system is paid. This paper proposes an eight-state Markov model for a transmission line and its protection system incorporating protection system miscoordination distinguishing from failure to operate and undesired trip. The situation of network lines in the period of simulation time has been determined by the sequential Monte Carlo method, and the reliability indices such as Loss of Load Probability (LOLP), Loss of Load Expectation (LOLE), Expected Energy Not Supplied (EENS), and Expected Frequency of Load Curtailment (EFLC) are calculated. The proposed model is applied to a 6-bus IEEE RBTS network, and the reliability indices are calculated and compared from both perspectives to show the importance of the proposed model.

## Review History:

Received: Aug. 01, 2023

Revised: Sep. 27, 2023

Accepted: Oct. 30, 2023

Available Online: Mar. 01, 2024

## Keywords:

Power system reliability

protection system failures

Sequential Monte Carlo method

Markov model of the protection system

incorrect relay setting

## 1- Introduction

Protection systems play a crucial role in the reliability and security of a power system. The proper operation of the protection systems in case of fault and not operating in unnecessary cases are essential features of protection systems. In most evaluations of power system reliability, it is usually assumed that the protection systems are completely reliable; so short circuits or failures of the component result in accurate tripping of the protection system and separating that component from the power system. However in actual evaluations of power systems, the assumption of being completely reliable is not a true statement, and the operation of protection systems should be considered in the reliability of power systems.

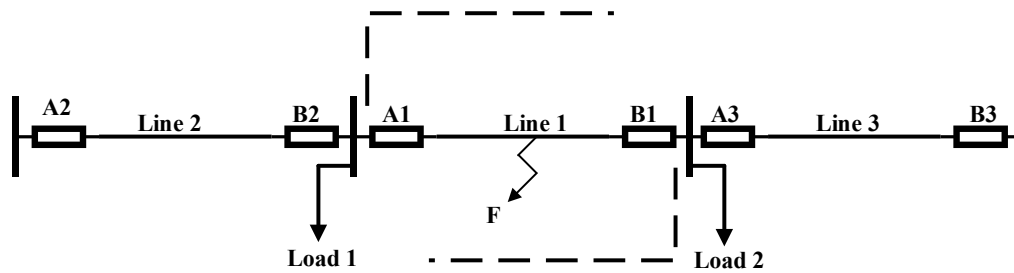
Generally, protection system failures have two modes: “failure to operate” and “undesired tripping”. These are the main reasons for wide-area and cascading outages of power systems [1] and affect their reliability [2, 3]. Many papers have evaluated the reliability of power systems considering the protection system failures. In [4-6], the effects of protection system failures on power system reliability have been assessed by the non-sequential Monte Carlo method. Ref. [7] presented a hybrid Markov model to determine the probability of the protection systems being unreadiness

and unavailable in transmission and distribution systems and the optimum value of the inspection interval has been estimated. In [8], a method to model the failure rate of transmission lines considering the protection failures and bad climate has been proposed, and the reliability indices of the system have been calculated by approximate and time series methods. Also in [9], a new model and concept considering protection system failures in the evaluation of power system reliability have been presented. The aim of [9] is to develop and extend the model to analyze the complex and related effects of the protection failures that result in separating several components instead of the failed ones. Ref. [10] has proposed the Bayesian network method based on analytical discussion to model the protection failure and showed its impact on power system reliability. In reference [11], the effect of protection failure on power system reliability has been shown considering the substation configuration as well as the protection schemes.

The settings of protection systems are performed by several methods [12-17]. These settings are such that protection systems must clear the fault in case of faults and separate the smallest part from the network. Usually, these methods aim to reduce the total operation time of the protection relays. If there is a failure of the protection system, settings with these methods could have different effects on power system reliability. Coordination or

\*Corresponding author's email: a.saberi@birjand.ac.ir





**Fig. 1. An example of a power system**

miscoordination between protection systems could affect power system reliability. Reference [18] deals with the effects of coordination and selectivity of protection systems on the reliability of distribution networks. It also presents an algorithm to implement analysis of the short circuit, coordination, and calculate the reliability indices. In [19], an algorithm based on Monte Carlo has been proposed. Then the reliability indices have been obtained considering the coordination between overcurrent relays. Ref. [20] evaluated the effects of coordination between protection systems on the reliability of power systems and the reliability indices have been obtained using the Monte Carlo method. In reference [21], the effects of two coordination methods and protection failures on the reliability indices of an interconnected sub-transmission system have been evaluated.

Protection systems can affect the reliability of power systems from two different aspects: First, the inappropriate operation of the protection system due to the failure in any of its components, and second, the erroneous operation of the protection system due to incorrect settings of its relays.

The coordination between protection systems can be investigated from two perspectives. In the first perspective, the primary protection does not operate because of a failure in the protection components (a circuit breaker, a relay, etc.), but the backup protection will operate. In this perspective, the settings of relays are such that proper coordination exists.

In the second perspective, the primary protection is healthy, but the incorrect settings result in the early operation of the backup protection before the primary protection. In this case, a larger segment of the network is isolated and the reliability of the network is degraded. Although the previous papers have evaluated the effect of protection system coordination on power systems in the presence of protection system failures, the coordination has not been studied from the second perspective.

In this paper, the miscoordination in the protection systems due to the incorrect settings of relays assuming healthy protection components has been studied. This miscoordination results in the backup protection operating before the primary protection system in case of fault, an outage in a big part of the network, and loss of load. So this paper aims to present a new model to separate these two different aspects of the effects of protection relay operating on the reliability of power systems.

This objective has been achieved by presenting an eight-state hybrid Markov model. This model has been implemented by the Monte Carlo method and has been applied to a 6-bus IEEE RBTS network. For evaluating the reliability several indices, including the Loss of Load Probability (LOLP), the Expected Energy Not Supplied (EENS), the Loss of Load Expectation (LOLE), and the Expected Frequency of Load Curtailment (EFLC), have been used. Results show that miscoordination due to incorrect settings similar to protection failures has a considerable effect on the reliability of power systems.

In the following section, the problem statement is provided using an example from a sample power system. In the next section, the proposed Markov model is presented, and the different states of the model are explained. In Section 4, the algorithm for model implementation is introduced. Then in Section 5, the results of the simulation carried out using MATLAB software are shown.

## 2- Problem Statement

The correct operation of the protection systems depends on the proper setting of protection relays, as well as the protection components being healthy on the other hand. Incorrect settings of the relays result in the miscoordination between primary/backup relays in the case of fault, then the backup protection operates before the primary protection. So that the healthy parts of the power system are lost resulting in an outage and loss of load. Also, the failure of any component of the protection system can cause failure to operate in the primary protection system and a big part of the network to be cut off. In this paper, these two perspectives will be separated.

For a better explanation of this subject, Fig. 1 has been shown as an example of a simple power system. This system has three lines: Line 1, Line 2, and Line 3. All lines are protected by protection systems at both ends.

If there is a fault on Line 1, several states could exist:

The first state: Protection system A1 is healthy and coordinated (correct settings). Therefore, the fault is fixed, and only Line 1 is separated from the system.

The second state: The protection system A1 is healthy but not coordinated, and the settings of relays are incorrect. In this case, the backup protection system A2 operates before primary protection A1, so both Line 1 and Line 2 and Load 1 are separated from the network.

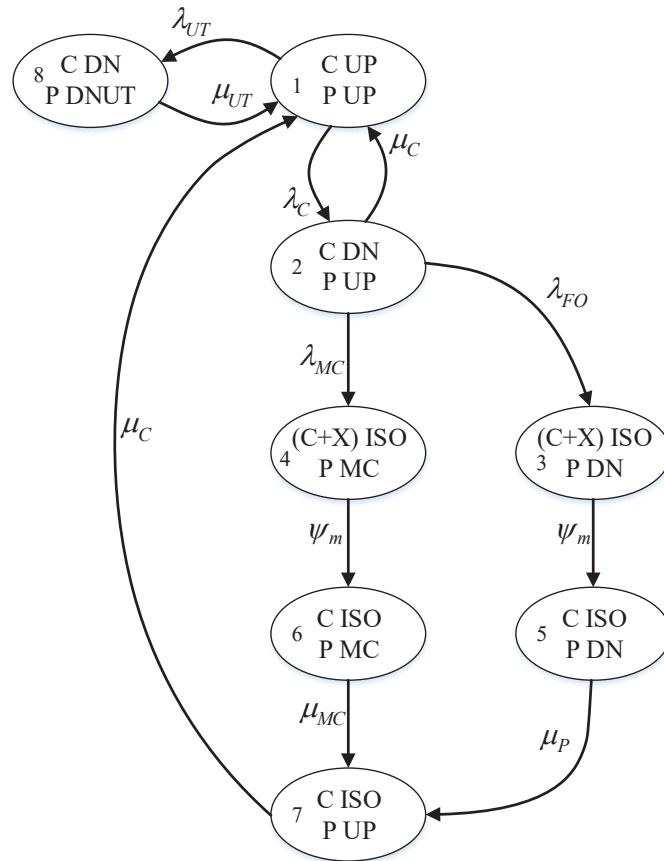


Fig. 2. The proposed Markov model

The third state: The protection system A1 fails to operate. In this case, with or without coordination, the backup protection A2 should operate; then Line 1 along with Line 2 and Load 1 are separated from the network.

These cases are true for the protection system of the other end of Line 1, and the operation of the protection system at one end could be different from that at the other end. For example, the protection system of one end of Line 1 could be at the first state, while the other end is at the third state. So, the number of states of the protection systems at both ends is equal to  $3^2 = 9$ .

All mentioned states assume that the backup protection is healthy, and its operation is deterministic. In this paper, the second and third states are separated while in the previous papers have been considered together.

For this purpose, in this paper, an eight-state Markov model is proposed. In the proposed model, the operation of the backup protection due to incorrect settings or the failures of the components of the primary protection is considered separately. The undesired tripping is also considered in this model.

### 3- The Proposed Markov Model

The proposed Markov model of this paper is a hybrid model incorporating the network component and the protection system at both ends. In this model, all possible states of the component and the protection system are considered. For the protection system of this model, three parts have been assumed. The first part is related to the failure to operate the primary relay due to protection system failure. The second part is related to the undesired trips of the protection system, and the third part is the miscoordination due to the incorrect settings.

Fig. 2 shows the proposed Markov model. This model is depicted for the protection system of one end of the component.

The symbols and letters used in the Markov model are as follows:

*C* Power system components including the lines and transformers.

*P* The protection system at one end of the power system (relay, circuit breaker, current, and voltage transformers).

$X$	The healthy power system component that is separated from the network when the backup protection operates.
$UP$	Shows a healthy condition
$DN$	Shows a faulty condition
$DNUT$	Shows the undesired tripping failure
$MC$	Shows the protection miscoordination
$ISO$	Separated from the network
$\lambda_c, \mu_c$	The failure and repair rates of the power system component
$\lambda_{FO}, \mu_P$	The failure and repair rates of the failure to operate of the protection system due to the failure of the protection equipment
$\lambda_{MC}, \mu_{MC}$	The failure and repair rates of the protection miscoordination due to the incorrect settings
$\lambda_{UT}, \mu_{UT}$	The failure and repair rates of the undesired tripping of the protection system
$\Psi_m$	The switching rate to restore the healthy part to the network

It is worth mentioning that in this Markov model, the power system component is modeled along with the protection system, at one end. Since the protection system at both ends could behave differently, all possible states must be considered.

The operation modes of this proposed model are as follows:

- State 1: The power system component and protection system are healthy and ready to operate. In this mode, there are two possible situations; one is the fault occurrence on the component and going to State 2, and the other is the undesired tripping of the protection system and going to State 8.

- State 2: The power system component has failed, and it is possible to be separated from the network by the operation of the primary protection system and go for repair (State 1), or the primary protection is failed and the backup protection operates (State 3), or the protection system has a miscoordination due to the incorrect settings such that the backup protection operates before the primary protection system (State 4).

- State 3: The primary protection fails to operate, therefore, the backup protection operates, and the faulty component is separated from the network along with one or several parts of the healthy component.

- State 4: The protection system has a miscoordination due to the incorrect settings such that the backup protection operates before the primary protection, and causes the faulty component to be separated from the network along with the healthy ones.

- State 5: The healthy components are restored to the network based on the switching rate, and only the faulty component is separated from the network. Then the primary protection is separated from the network for repair procedures (State 7).

- State 6: The healthy component is separated from the network due to the incorrect settings, restored to the network with the switching rate, and only the faulty component is

separated from the system. Then the protection system must be reset again.

- State 7: In this state, the failures of the protection system, including the failure to operate and undesired tripping, are fixed and it is ready to operate, but the power system component is separated from the network for the repair.

- State 8: The undesired tripping failure of the protection system causes the power system component related to this protection system to be separated from the network, and both the component and the protection system are separated from the network.

#### 4- The Algorithm to Solve the Problem

In this paper, the sequential Monte Carlo method has been used to implement the proposed Markov model. Generally, the Monte Carlo method is divided into two categories: sequential and non-sequential. In the sequential Monte Carlo method, the events can be considered in order of time, while in the non-sequential method, the time order is not necessary. One advantage of this method is that the probability distribution of the reliability indices could be also obtained.

In the following, the sequential Monte Carlo method is explained.

Fig. 3 shows the different states of a sample system divided into  $n$  states. In sequential Monte Carlo, starting from State1, transition times from State1 to States 2 to  $n$  are obtained by (1):

$$TTT_{1j} = -\frac{1}{TR_{1j}} \ln(U_{1j}) \quad (1)$$

Where  $j$  represents all states that can be obtained from State 1.  $TTT_{1j}$  and  $TR_{1j}$  are transition time and transition rate from State1 to State  $j$ , respectively.  $U_{1j}$  is a random number between 0 and 1 with a uniform distribution. This equation is obtained assuming that the distribution function is exponential and is calculated using the inverse transform method. So by calculating transition times from State 1 to all states from 2 to  $n$ , the shortest time associated with the  $j$ th state is selected and is determined as the residence time in State 1 [22-26]. This way, the model goes from State 1 to State  $n$ . This procedure is repeated for the whole simulation period.

In the following, the sequential Monte Carlo method for implementing the example power system, as shown in Fig. 1, is explained.

Based on this, the state of Line 1 (outage or not) is obtained as follows.

For protection system A1 (Fig. 1) which is at the left end of Line 1, the Markov model is implemented. Residence times for each state are calculated using equation (1). State 1 in the Markov model is the state that the line is healthy and ready to operate (Not outage), but in States 2 to 8, the line is faulty or is not ready to operate (Line outage). So, the times in hours that protection system A1 is in State 1 of the Markov model, number 1 is referred to its state, and number

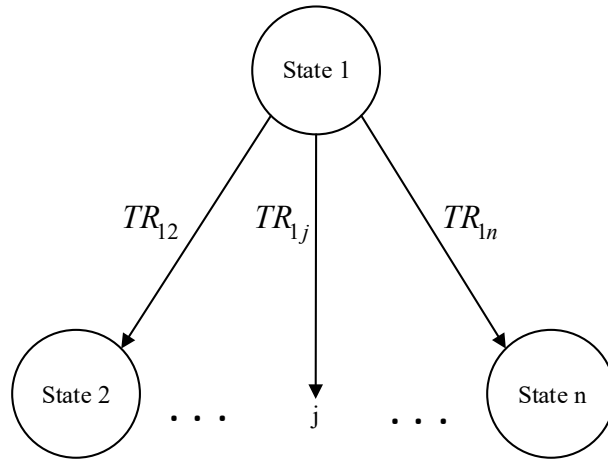


Fig. 3. Markov model of sample system in n-state

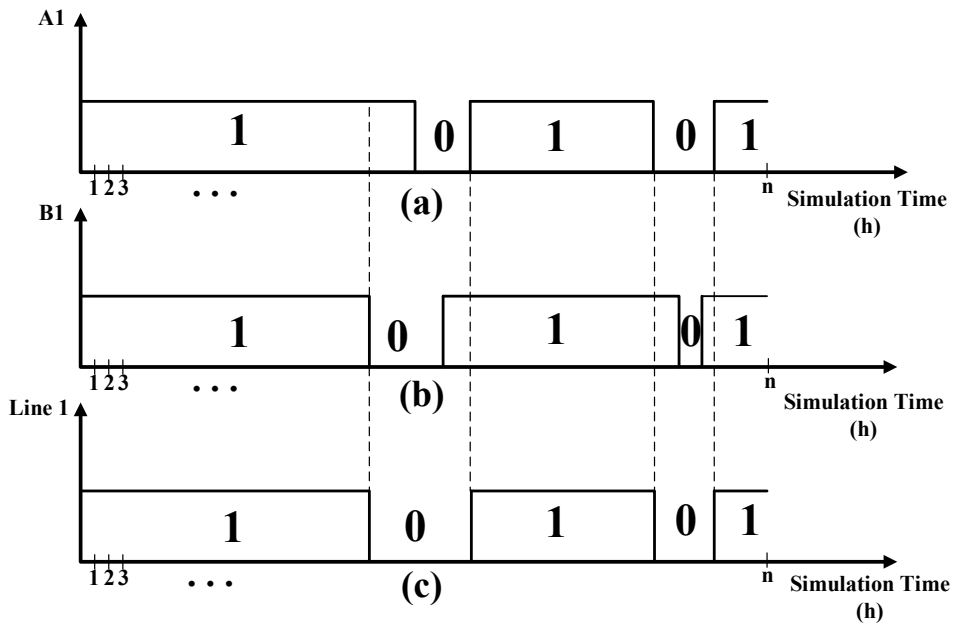


Fig. 4. (a) Time diagram for protection system A1; (b) Time diagram for protection system B1; (c) Time diagram for Line 1

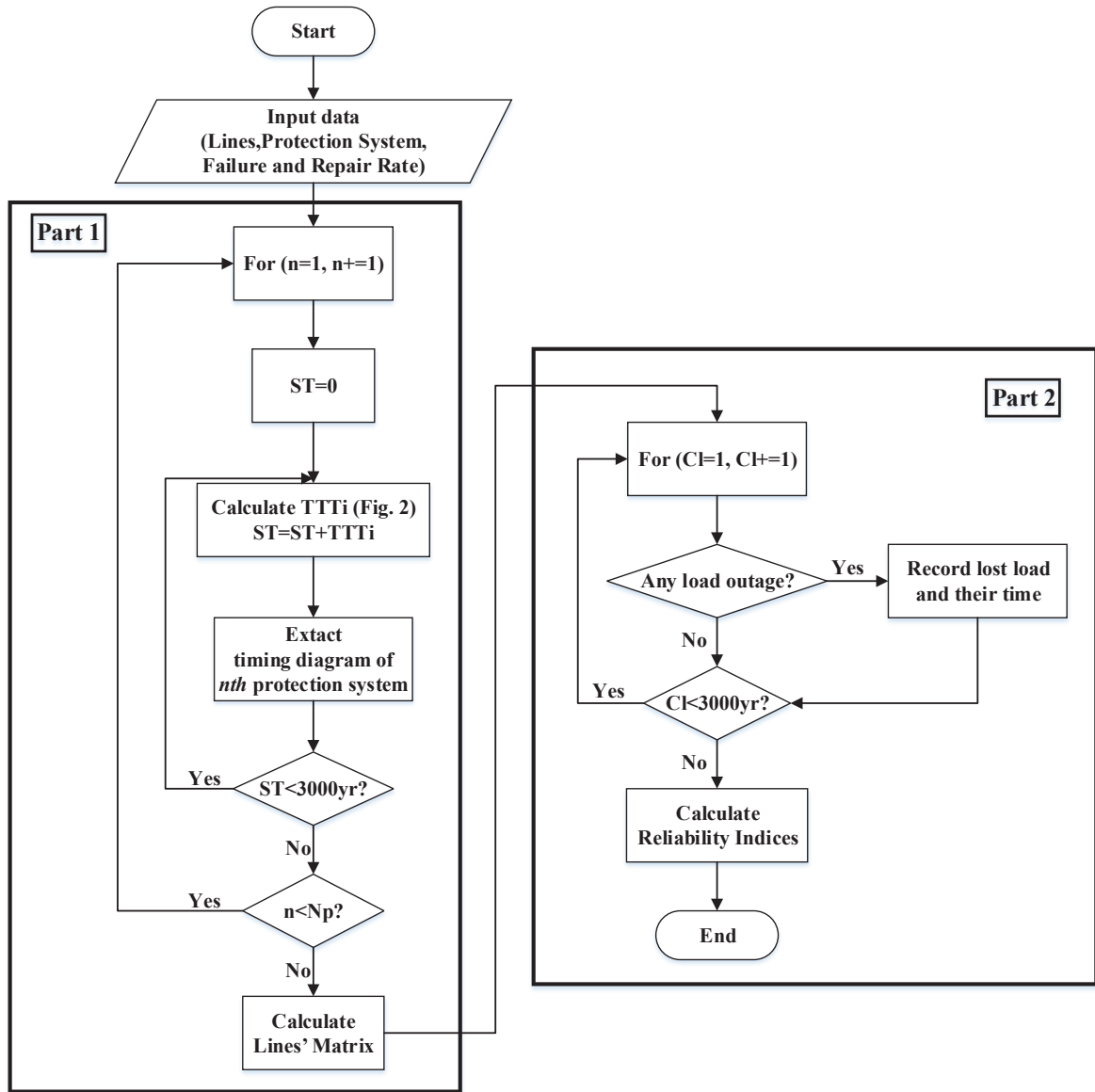
0 is referred to other states (State 2 to 8). Therefore, number 1 means being not outage, and number 0 means being outage. So, the situation of Line 1 is extracted and shown in Fig. 4. a. In this figure, the horizontal axis shows the simulation time.

The same procedure is applied to the protection system located at the other end of Line 1, as its results are illustrated in Fig. 4. b. Finally, the situation of Line 1 is obtained as Fig. 4. c by combining the data of Fig. 4. a and 4. b. In other words, the situation of Line 1 is determined by the collaboration of the protection systems located at both ends.

The proposed sequential Monte Carlo algorithm for implementing the Markov model and calculating the reliability indices, as shown in Fig. 5, includes two following parts:

**Part 1: Calculating the Lines' Matrix**

First, input information of the power system, including the information regarding the network structure, protection system, and the information related to the reliability of the power system component and the protection system, is entered. Then starting from Line1 of the power system, the Markov model is implemented for the protection system of each line, and the residence times in each state of the Markov model are calculated for all protection systems. These calculations are repeated for 3000 replications (years). In other words, one-year calculations are replicated 3000 times. This way, the timing diagram according to Fig. 4. a is extracted for the nth protection system. Then it is repeated for the protection system at the other end of the line, and Fig. 4.



**Np:** Number of protection system  
**ST:** Simulation time  
**n:** Protection system counter  
**Cl:** Column counter of lines' matrix

**Fig. 5. The Flowchart of the Proposed Algorithm**

b is constructed. This procedure is repeated for all protection systems at both ends of all lines. Finally, the situation of all network lines is extracted by the protection systems at both ends of the line known. Information regarding the situation of the lines for the simulation period is stored in a matrix called the lines' matrix as shown in Fig. 6.

The lines' matrix represents the situations of the lines in the whole simulation period. The number of rows and columns in this matrix shows the number of lines and simulation times in hours, respectively. In this matrix, number 1 means the line is healthy, and number 0 means the line is faulty or outage at that simulation time.

**Part 2: Calculating the reliability indices**

By knowing the situations of the lines during the simulation

time from the lines' matrix, the loss of load and their time are determined. Using this information, the reliability indices are calculated.

In this paper, the reliability indices, including the Loss of Load Probability (LOLP), the Loss of Load Expectation (LOLE), the Expected Energy Not Supplied (EENS), and the Expected Frequency of Load Curtailment (EFLC) are extracted [27]. These indices are defined as follows:

**Loss of load probability (LOLP):**

$$LOLP = \sum_{i=1}^{Ns} \frac{H_i t_i}{t_{total}} \tag{2}$$

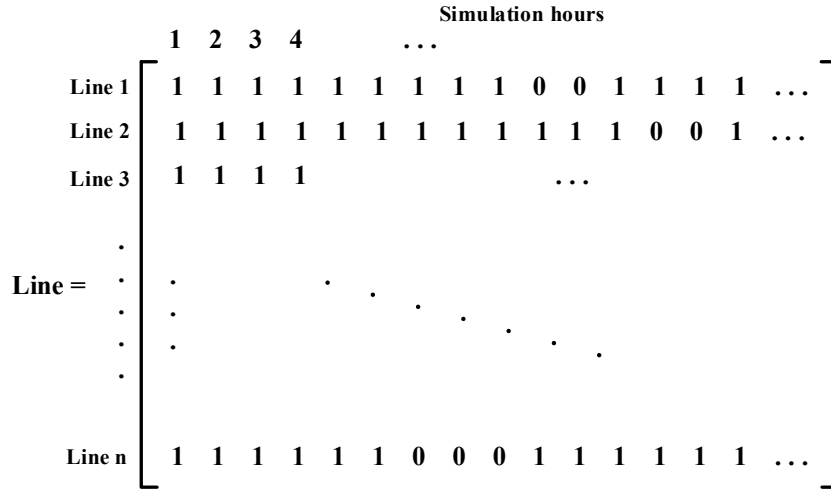


Fig. 6. The lines' matrix

where

$N_s$ : The number of simulation iterations;

$H_i$ : If there is a loss of load in the  $i^{th}$  iteration is equal to 1, otherwise is zero;

$t_i$ : The simulation time in the  $i^{th}$  iteration (1/yr);

$t_{total}$ : Total simulation time (1/yr).

**Loss of load expectation (LOLE):**

$$LOLE = LOLP \times 8760 \quad (hr / yr) \quad (3)$$

**Expected energy not supplied (EENS):**

$$EENS = \sum_{i=1}^{N_s} \frac{8760 R_i t_i}{t_{total}} \quad (MWhr / yr) \quad (4)$$

Where  $R_i$  is the value of loss of load in the  $i^{th}$  iteration.

**Expected frequency of load curtailment (ELFC):**

$$ELFC = \sum_{i=1}^{N_s} \frac{Z_i}{t_{total}} \quad (load / yr) \quad (5)$$

Where  $Z_i$  equals one if there is a loss of load in the  $(i-1)^{th}$  iteration and there is no loss of load in the  $i^{th}$  iteration, otherwise  $Z_i$  is zero.

### 5- Simulation Results

The proposed algorithm of Fig. 5 is applied to the 6-bus IEEE RBTS network [4]. Fig. 7 shows the single-line diagram of the network.

The total load of the network is 185 MW. This network has 9 lines and 17 protection systems of overcurrent type. Information related to the failure and repair rate and the switching rates are summarized in Table 1 [5, 27].

For comparing the analytical and the sequential Monte Carlo methods, the Limit Probability of each state of the Markov model (Fig. 2) is calculated. Based on the information in Table 1, the probability of the Markov model states is obtained from Equations (6) and (7) using the analytical method:

$$A = \begin{bmatrix} -\lambda_c - \lambda_{UT} & \lambda_c & 0 & 0 & 0 & 0 & 0 & 0 & \lambda_{UT} \\ \mu_c & -\mu_c - \lambda_{FOP} - \lambda_{MC} & \lambda_{FOP} & \lambda_{MC} & 0 & 0 & 0 & 0 & 0 \\ 0 & 0 & -\psi_m & 0 & \psi_m & 0 & 0 & 0 & 0 \\ 0 & 0 & 0 & -\psi_m & 0 & \psi_m & 0 & 0 & 0 \\ 0 & 0 & 0 & 0 & -\mu_p & 0 & \mu_p & 0 & 0 \\ 0 & 0 & 0 & 0 & 0 & -\mu_{MC} & \mu_{MC} & 0 & 0 \\ \mu_c & 0 & 0 & 0 & 0 & 0 & 0 & -\mu_c & 0 \\ \mu_{UT} & 0 & 0 & 0 & 0 & 0 & 0 & 0 & -\mu_{UT} \end{bmatrix} \quad (6)$$

$$\begin{cases} pA = 0 \\ \sum_{i=1}^8 p_i = 1 \end{cases} \quad (7)$$

In Equations (6) and (7),  $A$  is the transient matrix,  $p$  is the probability matrix of the states, and  $p_i$  is the probability of the  $i^{th}$  state. The sum of all state probabilities is one.

The probability of each state of the Markov model of Fig. 2 using the sequential Monte Carlo method for the protection system at one end of the line is calculated and presented in Table 2 with the results of the analytical method for comparison.

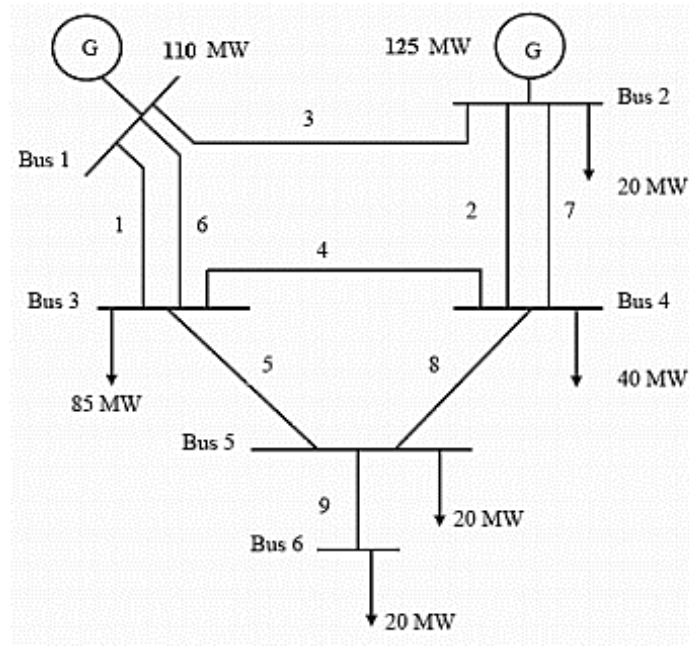


Fig. 7. The 6-bus IEEE RBTS network [4]

Table 1. The failure and repair rates and the switching time [5, 27]

Line	$\lambda_C$ (1/yr)	5
	$\mu_C$ (1/yr)	150
Protection System	$\lambda_{FO}$ (1/yr)	1
	$\mu_P$ (1/yr)	40
	$\lambda_{UT}$ (1/yr)	0.1
	$\mu_{UT}$ (1/yr)	40
	$\lambda_{MC}$ (1/yr)	1
	$\mu_{MC}$ (1/yr)	40
	$\Psi_m$ (1/yr)	10

As is can be observed from Table 2, the sequential Monte Carlo method has an appropriate accuracy for simulating the proposed model.

For comparing and indicating the effects of two perspectives on the protection system failure and the miscoordination due to incorrect relay setting on the power system reliability four cases have been considered.

Case 1: The protection system is healthy and coordinated.

Case 2: The protection system failures, including the failure to operate and undesired tripping, are considered.

Case 3: A healthy protection system and miscoordination due to the incorrect settings are considered.

Case 4: In addition to the protection failures, the miscoordination due to the incorrect settings is also considered (a combination of Cases 2 and 3).

One way to stop the Monte Carlo simulation is the convergence of the results to fixed values. Therefore, the number of simulation years is selected such that the results converge. Figures and 9 show the EENS and LOLP indices for 4 cases, respectively.

As it is apparent from the figures, the results have converged at 3000 years.

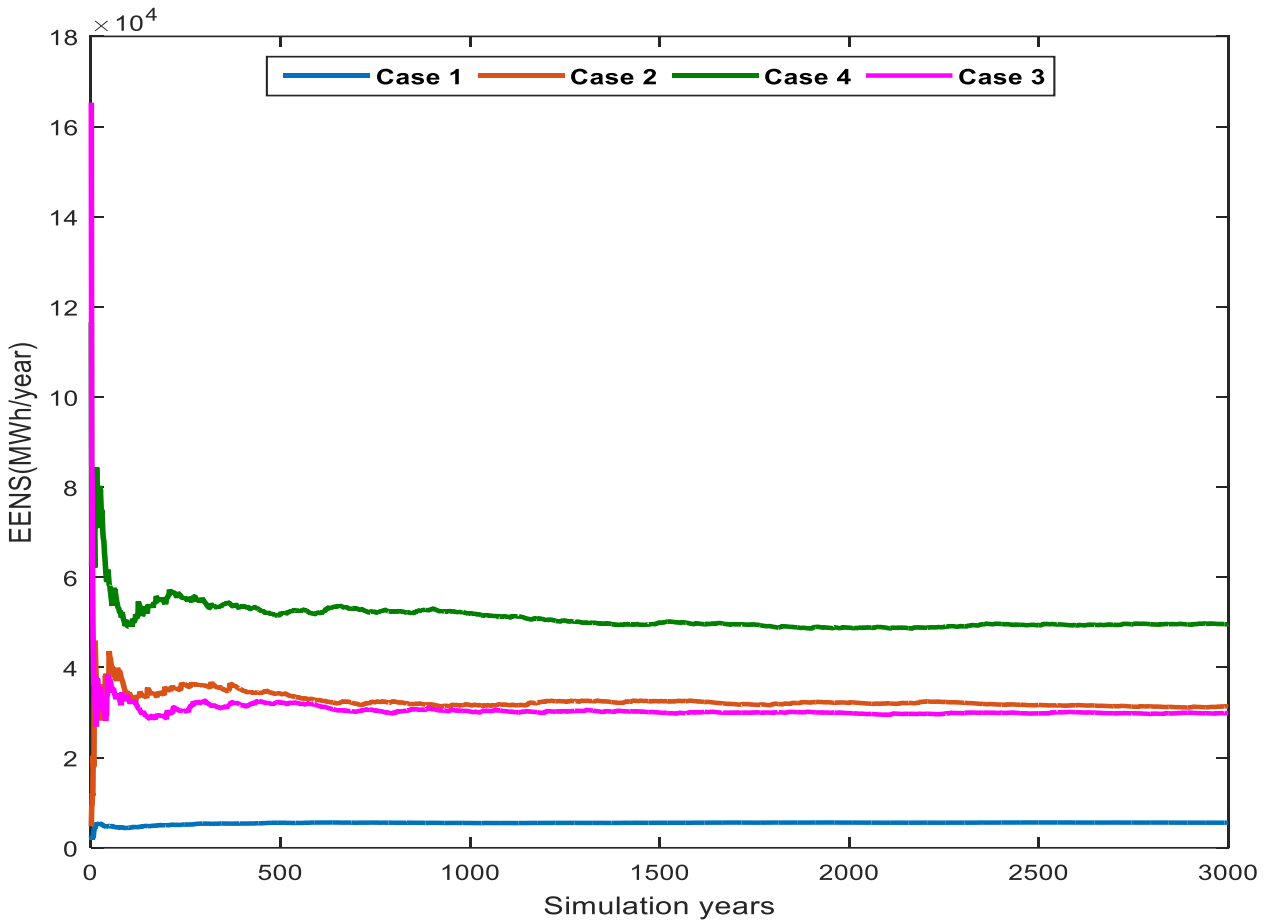
Also, Table 3 and Fig. 10 show the reliability indices in 3000-year simulations for all 4 cases.

The results of Table 3 and Fig. 10 show that the EENS in Case 1 is 5580 MWh/year, and in Case 2 is 31350 MWh/year. The LOLP index for Cases 1 and 2 are 0.0318 and 0.111, respectively. It can be concluded from these values that protection system failures have a considerable effect on the reliability of power systems. Comparing the EENS and LOLP

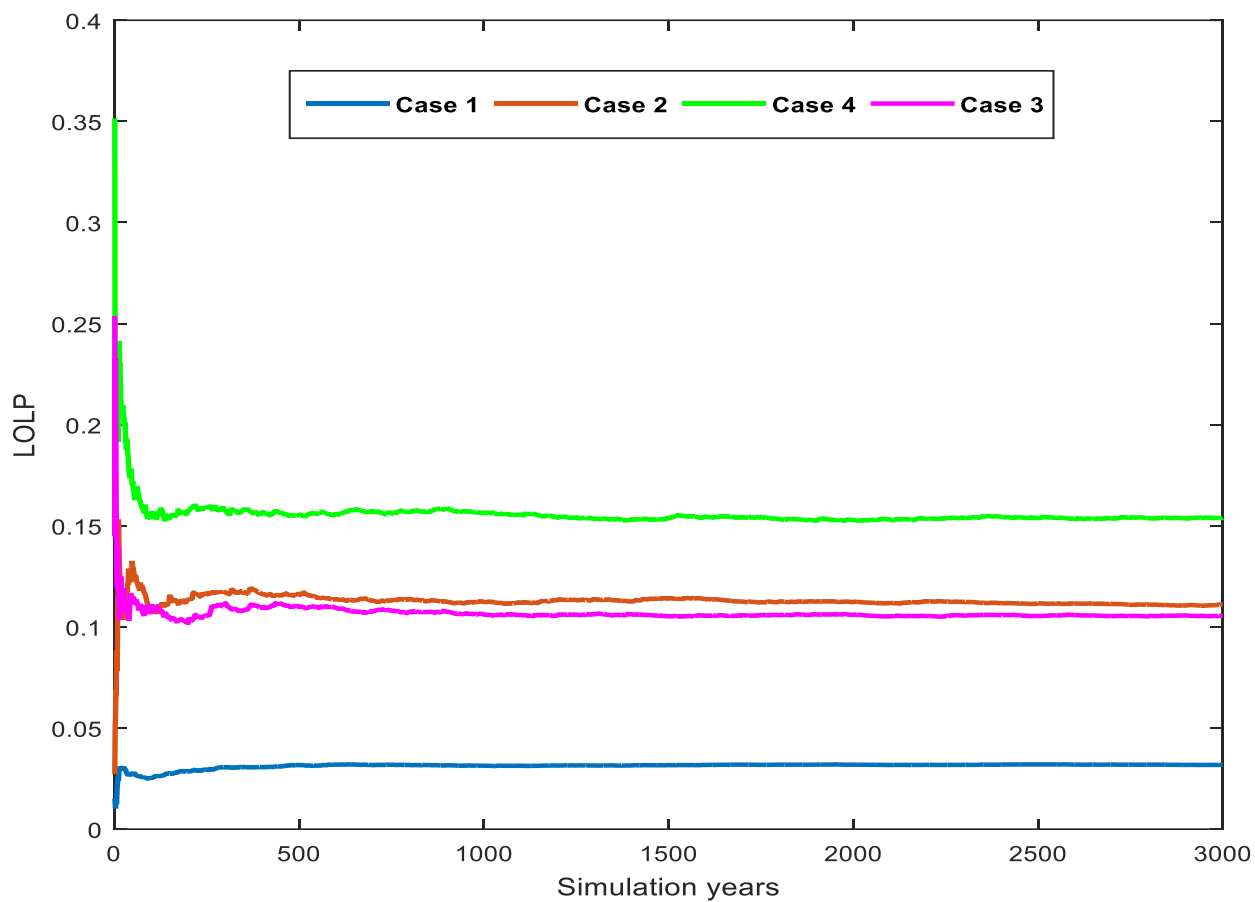


**Table 2. The probabilities of the proposed Markov model states**

	Analytical technique	Sequential Monte Carlo
P1	0.957802	0.957745
P2	0.031506	0.031539
P3	0.003150	0.003171
P4	0.003150	0.003160
P5	0.000787	0.000785
P6	0.000787	0.000789
P7	0.000420	0.000420
P8	0.002394	0.002387



**Fig. 8. The EENS reliability index for all 4 cases**



**Fig. 9. The LOLP reliability index for all 4 cases**

**Table 3. The reliability indices for all 4 cases**

	LOLP	LOLE (h/year)	EENS (MWh/year)	ELFC (/year)
Case 1	0.0318	278.64	5580	4.77
Case 2	0.1110	972.33	31350	9.52
Case 3	0.1054	921.01	29853	9.33
Case 4	0.1539	1348.4	49591	10.15

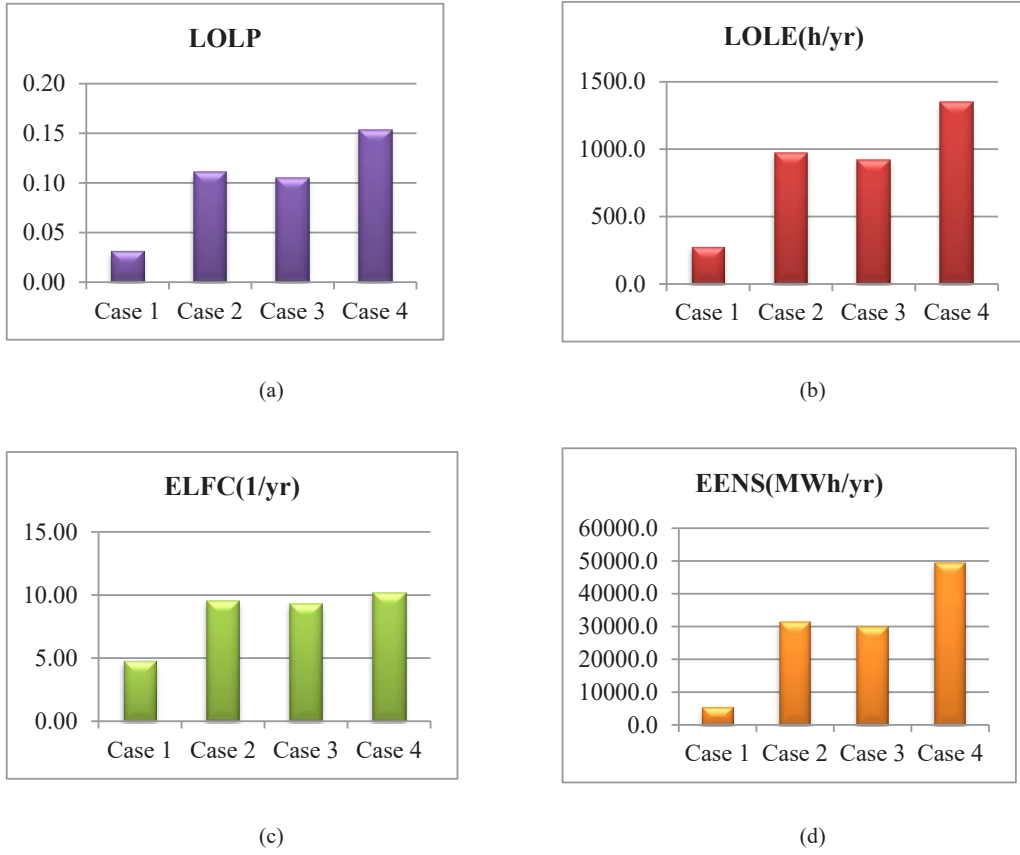


Fig. 10. The reliability indices of LOLP(a), LOLE(b), ELFC(c), and EENS(d) for all 4 cases

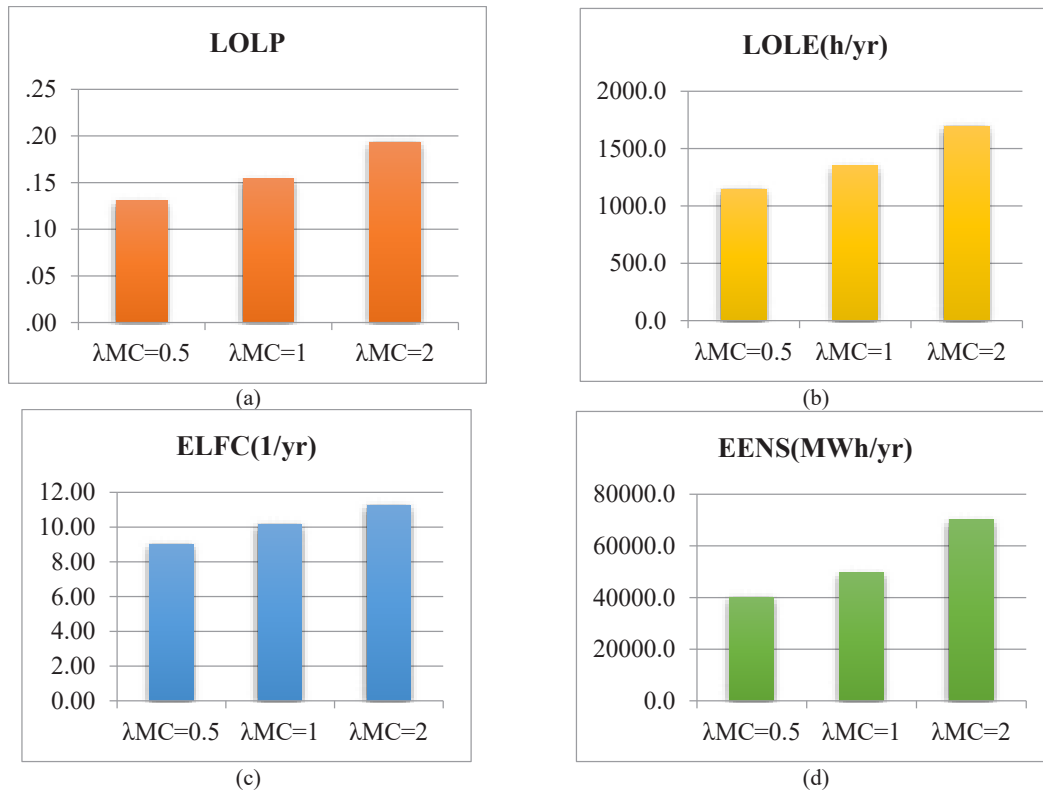


Fig. 11. The reliability indices for different miscoordination rates ((a): LOLP, (b): LOLE, (c): ELFC, and (d): EENS)

in Case 1 and 3, it can be said that the miscoordination due to the incorrect settings of the relays has a considerable impact on the reliability which is not less important than the protection system failures (Case 2). Also, the EENS and LOLP for Case 4 are 49591 MWh/year and 0.1539, respectively. These values have been increased by 58% and 38%, respectively, in comparison to Case 2. Also, the LOLE and ELFC have been increased by 38% and 6.6%, respectively.

The miscoordination due to the incorrect relay settings, which are considered as an independent factor affects the reliability indices. Therefore, the protection system coordination methods determining the value of the miscoordination could affect the reliability of the power system. Also, to illustrate the effect of miscoordination rates on power system reliability, the reliability indices are calculated for the various values of miscoordination rates in case 4.

The reliability indices for three different miscoordination rates ( $\lambda_{MC}$ ) are shown in Fig. 11. The results of this figure show that the LOLP, LOLE, ELFC, and EENS indices increase with an increase in the miscoordination rate.

## 6- Conclusion

The operation of the protection systems has a considerable effect on the power system reliability. The protection system failures result in loss of load and impose a blackout in the system. Furthermore, the incorrect settings of the protection relays that cause the miscoordination in the protection system are also affecting the power system reliability indices.

In this paper, an eight-state Markov model has been proposed that models the miscoordination due to the incorrect settings and the protection failures, separately. The proposed Markov model has been applied to a 6-bus IEEE RBTS network using the sequential Monte Carlo method. The results obtained from the simulation for 4 cases and the effect of each case on the reliability of the power system have been explained. Also, reliability indices are obtained for three different values of miscoordination rate. It can be concluded from the results that the miscoordination due to the incorrect settings has a considerable effect on the reliability indices of the power system as important as the protection system failures. Therefore, the settings due to the coordination methods could be effective in the reliability of the power system.

## References

- [1] R. Hu, X. Liu, Y. Huang, C. Chen, J. Zhang, Cascading Failure Risk Assessment Considering Protection System Hidden Failures, *Int J Mech Eng Appl*, 4(2) (2016) 50-58.
- [2] R. Graziano, V. Kruse, G. Rankin, Systems analysis of protection system coordination: A strategic problem for transmission and distribution reliability, *IEEE transactions on power delivery*, 7(2) (1992) 720-726.
- [3] J. Zhang, M. Ding, X. Qi, Y. Guo, Research on hidden failure reliability modeling of electric power system protection, *Energy and Power Engineering*, 5(04) (2013) 1377.
- [4] M.C. Bozchalui, M. Sanaye-Pasand, M. Fotuhi-Firuzabad, Composite system reliability evaluation incorporating protection system failures, in: *Canadian Conference on Electrical and Computer Engineering*, 2005., IEEE, 2005, pp. 486-489.
- [5] X. Yu, C. Singh, Power system reliability analysis considering protection failures, in: *IEEE Power Engineering Society Summer Meeting*, IEEE, 2002, pp. 963-968.
- [6] X. Yu, C. Singh, A practical approach for integrated power system vulnerability analysis with protection failures, *IEEE Transactions on power systems*, 19(4) (2004) 1811-1820.
- [7] P. Anderson, G. Chintaluri, S. Magbuhat, R. Ghajar, An improved reliability model for redundant protective systems-Markov models, *IEEE Transactions on Power Systems*, 12(2) (1997) 573-578.
- [8] E.S. Kiel, G.H. Kjølle, Reliability of Supply and the Impact of Weather Exposure and Protection System Failures, *Applied Sciences*, 11(1) (2020) 182.
- [9] K. Jiang, C. Singh, New models and concepts for power system reliability evaluation including protection system failures, *IEEE Transactions on Power Systems*, 26(4) (2011) 1845-1855.
- [10] M. Eliassi, H. Seifi, M.R. Haghifam, Incorporation of protection system failures into bulk power system reliability assessment by Bayesian networks, *IET Generation, Transmission & Distribution*, 9(11) (2015) 1226-1234.
- [11] F. Yang, A.S. Meliopoulos, G.J. Cokkinides, Q.B. Dam, Bulk power system reliability assessment considering protection system hidden failures, in: *2007 iREP symposium-bulk power system dynamics and control-VII. Revitalizing operational reliability*, IEEE, 2007, pp. 1-8.
- [12] H.A. Abyaneh, M. Al-Dabbagh, H.K. Karegar, S.H.H. Sadeghi, R.J. Khan, A new optimal approach for coordination of overcurrent relays in interconnected power systems, *IEEE Transactions on power delivery*, 18(2) (2003) 430-435.
- [13] M. Azari, K. Mazlumi, M. Ojaghi, Efficient non-standard tripping characteristic-based coordination method for overcurrent relays in meshed power networks, *Electrical Engineering*, (2022) 1-18.
- [14] T. Keil, J. Jager, Advanced coordination method for overcurrent protection relays using nonstandard tripping characteristics, *IEEE transactions on power delivery*, 23(1) (2007) 52-57.
- [15] A.S. Noghabi, H.R. Mashhadi, J. Sadeh, Optimal coordination of directional overcurrent relays considering different network topologies using interval linear programming, *IEEE Transactions on Power Delivery*, 25(3) (2010) 1348-1354.
- [16] A.S. Noghabi, J. Sadeh, H.R. Mashhadi, Considering different network topologies in optimal overcurrent relay coordination using a hybrid GA, *IEEE Transactions on Power Delivery*, 24(4) (2009) 1857-1863.
- [17] F. Razavi, H.A. Abyaneh, M. Al-Dabbagh, R. Mohammadi, H. Torkaman, A new comprehensive

- genetic algorithm method for optimal overcurrent relays coordination, *Electric Power Systems Research*, 78(4) (2008) 713-720.
- [18] M. Boaski, M. Sperandio, D. Bernardon, C. Barriquello, D. Porto, M. Ramos, Methodology for coordination and selectivity of protection devices with reliability assessment, in: 2017 52nd International Universities Power Engineering Conference (UPEC), IEEE, 2017, pp. 1-6.
- [19] I.S. Hernanda, E.N. Kartinisari, D.A. Asfani, D. Fahmi, Analysis of protection failure effect and relay coordination on reliability index, in: 2014 The 1st International Conference on Information Technology, Computer, and Electrical Engineering, IEEE, 2014, pp. 366-371.
- [20] M. Jazaeri, M. Farzinfar, F. Razavi, Evaluation of the impacts of relay coordination on power system reliability, *International Transactions on Electrical Energy Systems*, 25(12) (2015) 3408-3421.
- [21] K. Mazlumi, H.A. Abyaneh, Relay coordination and protection failure effects on reliability indices in an interconnected sub-transmission system, *Electric Power Systems Research*, 79(7) (2009) 1011-1017.
- [22] J.D. Barbosa, R.C. Santos, J.F. Romero, P.T. Asano, A.V. Neto, J.B. Camargo, J.R. Almeida, P.S. Cugnasca, A methodology for reliability assessment of substations using fault tree and Monte Carlo simulation, *Electrical Engineering*, 101 (2019) 57-66.
- [23] R. Billinton, A. Sankarakrishnan, A comparison of Monte Carlo simulation techniques for composite power system reliability assessment, in: IEEE WESCANEX 95. Communications, Power, and Computing. Conference Proceedings, IEEE, 1995, pp. 145-150.
- [24] R. Billinton, W. Wangdee, Impact of utilising sequential and nonsequential simulation techniques in bulk-electric-system reliability assessment, *IEE Proceedings-Generation, Transmission and Distribution*, 152(5) (2005) 623-628.
- [25] Y. Massim, A. Zeblah, M. Benguediab, A. Ghouraf, R. Meziane, Reliability evaluation of electrical power systems including multi-state considerations, *Electrical Engineering*, 88 (2006) 109-116.
- [26] A. Sankarakrishnan, R. Billinton, Sequential Monte Carlo simulation for composite power system reliability analysis with time varying loads, *IEEE Transactions on power Systems*, 10(3) (1995) 1540-1545.
- [27] H. Lei, C. Singh, Power system reliability evaluation considering cyber-malfunctions in substations, *Electric Power Systems Research*, 129 (2015) 160-169.

#### HOW TO CITE THIS ARTICLE

S. Sabzebin, A. Saberi Noghabi, K. Mazlumi, Evaluation of Power System Reliability Incorporating Protection System Miscoordination, *AUT J. Elec. Eng.*, 56(2) (2024) 291-304.

DOI: [10.22060/ej.2023.22588.5550](https://doi.org/10.22060/ej.2023.22588.5550)



