



Performance evaluation of the first Iranian large-scale photovoltaic power plant

Mehran Pirzadi¹, Ali Asghar Ghadimi^{2,*}

¹Student, faculty of engineering, Arak University, Arak, Iran

²Associated Professor, faculty of engineering, Arak University, Arak, Iran

ABSTRACT: In recent years, due to the fact that non-renewable energy is coming to an end, renewable energy is expected to provide a significant part of the future needs of Iran. Among these energies, solar energy can be used in a wider range of country, due to availability, proper radiation intensity, high sunshine during the year (about 300 sunny days per year), Installation in the desired power and a lot of land in many parts of the country will have a significant share. The purpose of this paper is to analyze the performance of 1 MW Arak solar power plant (Iran's first megawatt power plant) according to IEC-61724 standard using data recorded over a year (November 2016 to November 2017). The Arak Solar Power Plant was built at latitude of 34° 3', 2" north, and longitude 49° 47' 47" at an altitude of 1700 meters above sea level. The plant has the capacity of 1 MW in a 1.6-acre land with 3920 modules (1920*260 Watt Monocrystals and 2000*250 Watt Polycrystals) in 200 structures and four inverters (each with a capacity of 250 kW). The information of this power plant is recorded in fifteen-minute intervals, which according to IEC-61724, this power plant is in the class B and we can do one-year performance analysis. In this paper, the performance parameters of the system are presented, also a table for comparison with other power plants in some parts of the world has been created.

Review History:

Received: 2019-12-24

Revised: 2020-02-10

Accepted: 2020-02-24

Available Online: 2020-06-01

Keywords:

Photovoltaic power plant

Energy yield

Loss

Performance ratio

Grid-connected

1. INTRODUCTION

In recent years, given that nonrenewable energy is coming to an end, renewable energy is projected to provide a significant part of Iran's future energy needs[1]. Among these energies, due to low maintenance costs, availability, appropriate radiation intensity, the number of sunny days during the year and the possibility of use in a wide range of country with plentiful land solar energy will have a significant share in most parts of the country [2]. The first Iranian PV power plant was opened in Yazd in 1993 and started off-grid, and so far small scale solar power plants have been established throughout Iran. In 2017, the first large-scale power plant in Iran with a capacity of 1 MW was constructed in Arak. Subsequently, in 2018, large-scale power plants were built in Hamadan, Esfahan, and Kerman [3].

The energy produced by a Photovoltaic Power Plant (PVPP) depends on various parameters such as panel technology (mono c-Si or multi c-Si), variation of solar radiation, environment condition (ambient temperature, pollution, humidity, and dust), type of system design, and type and number of converters. However, the amount of injected energy to the grid is related to the network and PVPP rate of failure and maintenance time, and also PVPP operation strategy. In the initial design of the PVPP, the information is

collected from various sources such as meteorological stations, related software, and practical experience and the plant will be built on that basis. But in practice, conditions may arise where the actual performance of the plant is different from design. Therefore, performance evaluation of a PVPP and its standard performance indicators can be used to identify problems and barriers reducing plant efficiency. An assessment of a power plant can also be a guide for installing new PVPP and future investments.

In this regard, due to the importance of the issue and the harmonization of international assessments, the IEC began to issue and publish a standard with IEC-61724 in 1998, and since then, PVPP has been evaluated in accordance with this standard. More recently, in 2018, the standard has been completed and published in three sections Monitoring, Capacity evaluation method, and Energy evaluation method. The monitoring part should be used to evaluate PVPP performance.

Performance evaluation of several PVPP around the world has been done and some of them published in the literature. There are a few that analyze types of PVPP. Rooftop[4-10], small scale[11], large scale[12-15], and off-grid[16] are evaluated by the standard in different countries. Some of them analyze various parameters affect the efficiency of PVPP such as: ambient temperature, radiation, relative humidity [17-24]. The others evaluated different geographic

*Corresponding author's email: a-ghadimi@araku.ac.ir



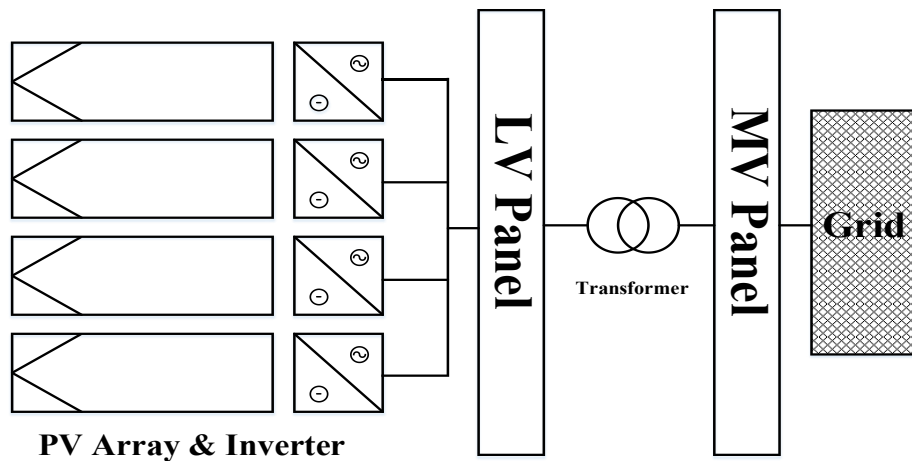

Fig. 1. Schematic diagram of the grid-connected PV plant

locations[25], dust levels[22], tracking systems[26-30], concentrating photovoltaic/thermal system[31-33], and different technologies [34] effect on the amount of energy produced by the PVPP. However, most of these studies only considered the technical performance of the installations (using parameters such as performance ratio and final energy yield), with little or no attention paid to distribution network operation on the energy injected and PVPP performance. In Iran, there is no information available on the actual operation and energy production from a large-scale PVPP.

In this paper, the performance of Arak's 1MW_p PVPP has been evaluated as the first large-scale power plant in Iran. In this assessment, the latest version of the standard in 2018 is used and system performance is evaluated with standard indices. Also, in this paper, the effects of the operation and grid failure on PVPP performance are discussed and solutions will be presented.

2. DETAILS OF THE POWER PLANT (GEOGRAPHIC/CLIMATIC DATA)

The PVPP in Arak was built at the latitude of $34^\circ 3' 2''$ N, and longitude $49^\circ 47' 47''$ E at an altitude of 1700 meters above sea level. The ambient air temperature varies between -14°C and 41°C over the year.

2.1. PV array data

The 1MW_p PVPP has divided into 4 segments of 250kW_p each. Standard 60-cell PV modules are placed on a fixed supporting construction at a 30-degree angle, the ground below them is covered by sand, and the free air passes through the modules. A string is formed by connecting 20 modules in series. The strings are joined in parallel at the array junction box.

2.2. Power conditioning unit

In this PVPP four inverters which are manufactured by the Astrid Company in Italy are used. Each one of the 250kW inverters is supplied from 50 PV array strings. The operation voltage of the inverters is between 450 - 820 V DC.

The schematic diagram of the power plant is shown in Fig. 1. In this Fig. 1 String = 20 module = 5kW_p . 50 strings are connected to an inverter.

2.3. Power evacuation

Inverter output at 300 V, 50 Hz is fed to 1.25 MVA, 300 $V_{ca}/20\text{kV}$, and 50 Hz transformers for stepping up the voltage to 20 kV level for grid export. An electronic meter records the energy fed to the grid. The distance between the power plant and the nearest substation is 6 kilometers and the energy produced by this power plant is fed to the middle of a 20kV feeder of substation.

2.4. Monitoring of the data

The sensors type, number and recording interval to be monitored in PVPP indicated in IEC61724-1 which is categorized as classes A, B, and C. Based on gathered data, different analysis and evaluation can be performed in each class [35]. Arak PVPP monitoring system is class B so the data recording interval for this plant is fifteen minutes and basic system performance assessment, documentation of a performance guarantee, and system losses analysis can be performed. The data logger records solar irradiance, DC power, AC power, AC energy fed to the grid, energy from PV array and module temperature at an interval of every 15 min using different measurement sensors. Using these values of power, total DC and AC energy generated over a day, month, and year are calculated. From the recorded weather data, module temperature is observed more than 40°C over most part of the day during peak summer season and module temperature reaches up to 64.82°C in summer. Fig. 2-a shows the variation of solar irradiance and module temperature measured on a typical summer day in Jun 2018. In that day the highest amount of solar radiation and module temperature is at 957W/m^2 and 54°C , respectively. A similar graph using the monitored data on a typical winter day in January 2018 is shown in Fig. 2-b. solar irradiation reaches peaks up to 776W/m^2 and 37°C . The highest amount of solar radiation from November 2017 to October 2018 is 1169.93W/m^2 and

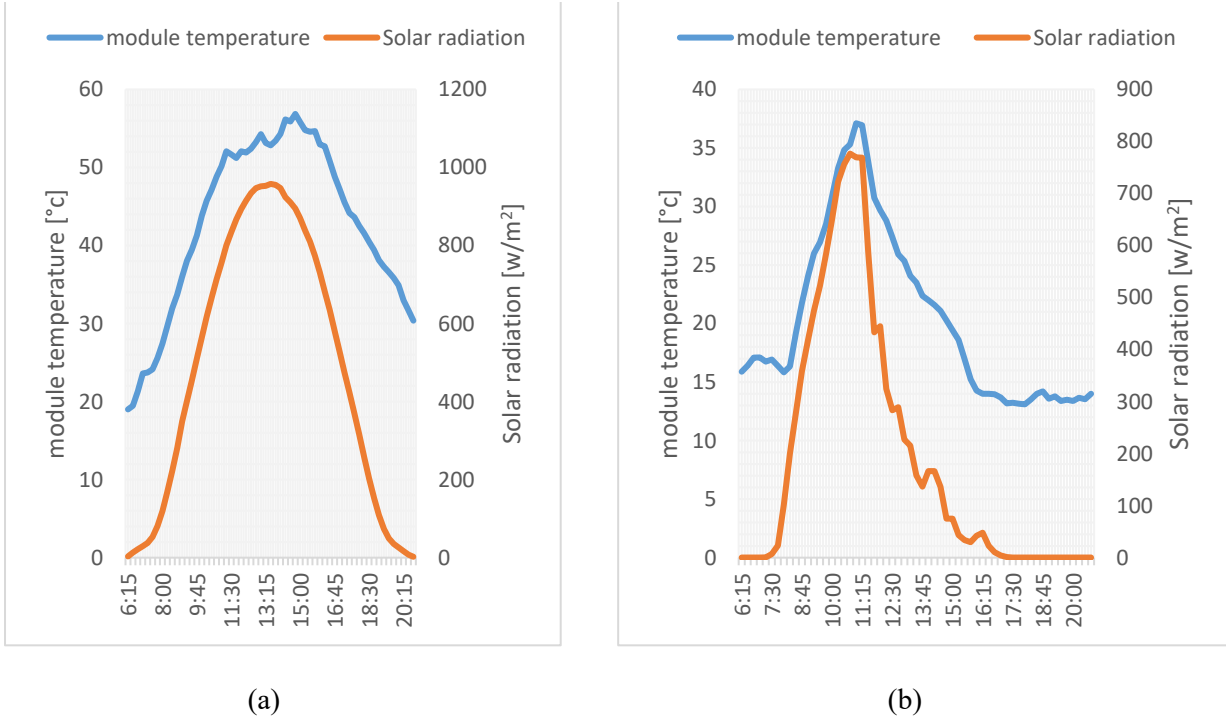

Fig. 2. Solar irradiance and module temperature on a) a day in summer b) day in winter.

the maximum PV modulus temperature is 64.82 °C. The daily average annual temperature of the modules is around 40°C.

3. INDICES FOR PERFORMANCE ANALYSIS OF GRID-CONNECTED PV SYSTEMS

A number of parameters can be calculated using the monitored data over a reporting period (τ), such as day, month or year. In IEC 61724-1 four categories of indices are defined for performance evaluation of grid-connected PVPP including Energy, Performance, Loss, and Efficiency indices. In this section, definitions and equations of the derived parameters as per IEC 61724-1 standard are given.

3.1. Electrical energy

Energy may be derived from the integral of their corresponding measured power parameters over the reporting period. Alternatively, the energy quantities may be taken directly as measurement readings from the sensors. The energy is as the following terms.

3.1.1. DC output energy

The PV array DC output energy is given by:

$$E_A = \sum_k P_{A,k} \times \tau_k \quad \text{kWh} \quad (1)$$

In these formulas k just is a counter.

3.1.2. AC output energy

The AC output energy calculated by Eq. (2) .

$$E_{OUT} = \sum_k P_{OUT,k} \times \tau_k \quad \text{kWh} \quad (2)$$

The daily values of DC output energy and AC output energy can be found from Eqs. (3) & (4) respectively .

$$E_{A,d} = \sum_{day} P_{A,k} \times \tau_k \quad \text{kWh} \quad (3)$$

$$E_{OUT,d} = \sum_{day} P_{OUT,k} \times \tau_k \quad \text{kWh} \quad (4)$$

Monthly and annual average values of energy outputs can be calculated similarly.

3.2. Performance parameter

Index for performance of PV arrays referred as yield in standard and literatures [11]. Yield indicates actual array operation relative to its rated capacity.

The specific yield is an energy quantity in a defined arbitrary period such as day to the array power rating P_0 which have the unit of kWh/kWp. The ratio of units is equivalent to hours, and the yield ratio indicates the equivalent amount of time during which the array would be required to operate at P_0 to provide the particular energy quantity measured during the reporting period.

3.2.1. PV array energy yield

The PV array energy yield Y_A is the array energy output (DC) per rated kW (DC) of installed PV power. Y_A can be calculated by Eq. (5) .

$$Y_A = E_A / P_0 \quad \text{kWh/kW}_p \quad (5)$$

3.2.2. Final system yield

The final PV system yield Y_f is the net energy output of the entire PV system (AC) per rated kW (DC) of installed PV array. The final system yield is given by :

$$Y_f = E_{OUT} / P_0 \quad \text{kWh/kW}_p \quad (6)$$

3.2.3. Reference yield

When it's mentioned in a PV module datasheet it has a nominal power of P_0 , it means that the module produces this power at the STC condition. But in real condition because of differences in irradiance, temperature, environmental condition, and panel life produced power is different from P_0 . Reference yield is an index that represents the under ideal conditions obtainable energy.

The reference yield is the total in-plane irradiance H (kWh/m²) divided by the PV's reference irradiance $G_{i,ref}$ (equals 1000 W/m²). Therefore, Y_r is in unit of kWh/kW and is the number of equivalent hours in which solar radiation is as STC. It is a function of the location, the orientation of the PV array, and month-to-month and year-to-year weather variability.

$$Y_r = H_i / G_{i,ref} \quad \text{kWh/kW}_p \quad (7)$$

Where each irradiation quantity H is calculated by summing the irradiance as follows :

$$H_i = \sum_k G_{i,k} \times \tau_k \quad \text{kWh/m}^2 \quad (8)$$

3.3. Energy losses

Energy losses arise in various components in a grid-connected PVPP under real operating conditions. The main losses are PV array capture losses and system losses (such as: wiring losses from inverter to transformer and inverter loss). Capture losses can be divided into thermal losses and miscellaneous losses. The thermal capture losses are due to PV array operation at temperatures except for 25 °C. The miscellaneous capture losses are due to any reasons such as wiring losses from PV panels to inverters, shading, improper operation, soiling and non-ideal maximum power point tracking as well as component failure. Most of the losses on the AC side are related to inverter and transformer losses, and AC side wiring also has a small amount of losses. The losses can be calculated by subtracting yields. The yield losses also have units of kWh·kW⁻¹ (or h). They represent the amount of time the array would be required to operate at its rated power P_0 to provide for the respective losses during the reporting period.

3.3.1. Array capture loss

The array capture loss denoted as L_c represents the losses due to array operation, including array temperature effects, soiling, etc., and is defined as :

$$L_c = Y_r - Y_A \quad \text{kWh/kW}_p \quad (9)$$

3.3.2. Balance of systems (BOS) loss

The BOS loss, L_{BOS} , represents the losses in the system components, including the inverter and all wiring and junction boxes, and it can be calculated from Eq. (10) .

$$L_{BOS} = Y_A - Y_f \quad \text{kWh/kW}_p \quad (10)$$

3.3.3. Performance ratio

The performance ratio PR is the percentage of the system's final yield Y_f to its reference yield Y_r , and indicates the overall effect of losses on the system output due to both array temperature and system component inefficiencies or failures, including BOS components. It is defined as :

$$PR = Y_f / Y_r = (E_{out} / P_0) / (H_i / G_{i,ref}) \quad (11)$$

3.4. Efficiencies

3.4.1. Array (DC) efficiency

The rated array efficiency is given by :

$$\eta_{A,0} = P_0 / (G_{i,ref} \times A_a) \quad (12)$$

Where the overall array area A_a is the total module area, corresponding to the sum of the areas of the front surfaces of the PV modules as defined by their outer edges. The mean actual array efficiency over the reporting period is defined by :

$$\eta_A = E_A / (H_i \times A_a) \quad (13)$$

3.4.2. System (AC) efficiency:

The mean system efficiency over the reporting period is defined by :

$$\eta_f = E_{OUT} / (H_i \times A_a) = \eta_{A,0} \times PR \quad (14)$$

3.4.3. BOS efficiency

The mean BOS efficiency over the reporting period can be defined as Eq. (15) .

$$\eta_{BOS} = E_{OUT} / E_A \quad (15)$$

Eqs. (5) - (15) can be used to calculate any parameter by taking appropriate energy quantities and summation periods. The monthly yields can be expressed in hours per month and annual yields in hours per year units.

3.4.4. Capacity factor

Capacity factor (CF) is a concept to show how much energy an electric power generation unit injected to the grid. If the power plant works at its nominal power continuously, the CF would be one. The CF is defined as the ratio of delivered energy from the power plant over a year to the maximum energy that would be injected to the grid if it worked at the rated power for 24 hours in a year. It's given as [4]:

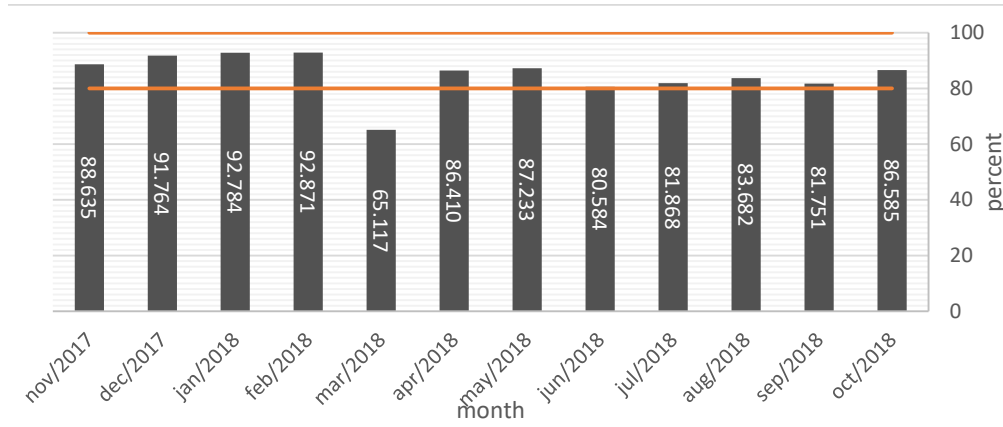

Fig. 3. Performance ratio values

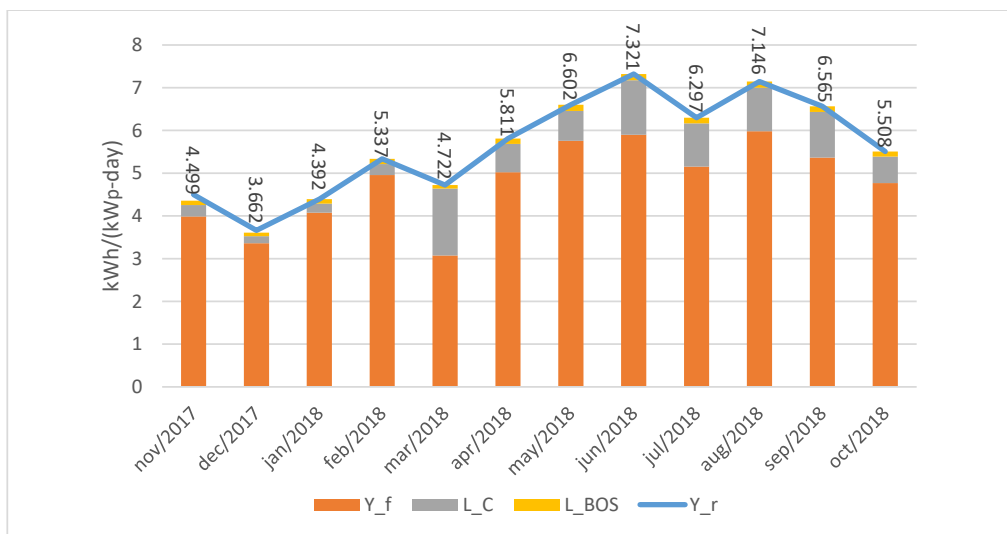

Fig. 4. Monthly average daily array yield, final yield, capture losses, and system losses

$$CF = \frac{\sum_{year} E_{OUT}}{P_0 \times 8760} = \frac{\sum_{year} Y_f}{24 \times 365} \quad (16)$$

4. OPERATIONAL PERFORMANCE OF ARAK PVPP

In this section, the parameters defined are calculated for Arak PVPP which its detail is described in section 2. The analysis is done for one year captured 15 min. data from first of November 2017 to last of October 2018.

4.1. Monthly and annual average parameters

The performance ratio is calculated for a year, from November 2017 to October 2018. The performance ratio is shown in Fig. 3. Performance ratio in March is below 0.8 and for other months it is higher than 0.8. Investigating data in this month shows the invalid operation of the PVPP in this period. The highest performance ratio is 0.928 for February and the lowest efficiency ratio of 0.65 for March.

In PVPP systems there is another terminology named as capacity factor (CF). This parameter is identified as the ratio of annual real energy injected to the ideal energy that can be produced. The ideal energy means the amount of energy that PV system can supply if operated at rated power for 24 h in a day for a year [11]. The capacity factor shows the operation performance of PVPP. The greater CF means better irradiance, less outage of network and system, and hence greater revenue for investors. The capacity factor for Arak PVPP is found to be 19.9 % in the period of November 2017 to October 2018. If the system failure and network failure and inaccurate operation are not taken into account for this power plant, the capacity factor increases to 21.2 %.

In order to distinguish the system performance in different weather conditions, reference yield, final yield, array capture losses and balance of system losses are calculated using the monitored data at 15 min. intervals in each month. Fig. 4 shows the result for the selected year. Also, the monthly average of energy fed to the grid per day for the months of the

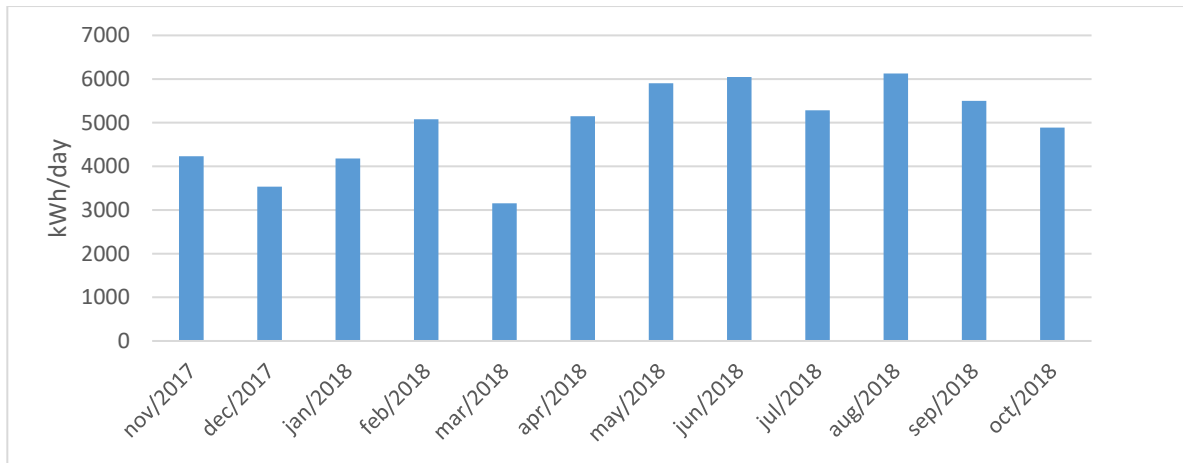

Fig. 5. The monthly average daily output energy

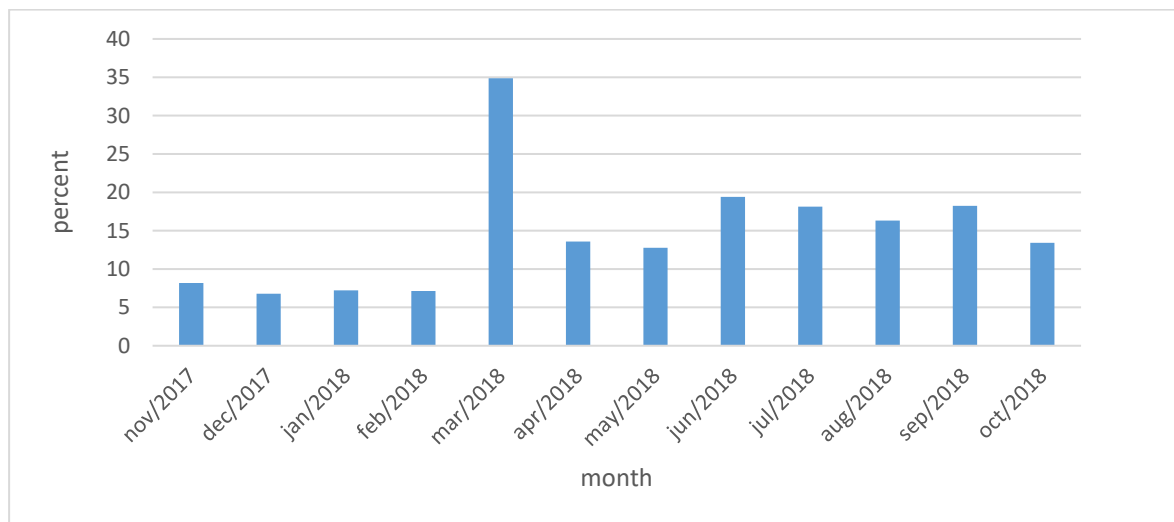

Fig. 6. Monthly percentage loss of reference yield

year is shown in Fig. 5. The highest value is in August equal to 6126.85 kWh/day and the lowest is in March which is 3454.5 kWh/day. In this calculation, the energy not supplied due to the system and network outage is considered as capture loss.

Fig. 6 shows the loss percentage of the reference yield for all months of the year. The highest loss in March was recorded with 34.88% of the reference yield and the lowest loss was 6.79% of the reference yield for December. The high level of loss in March is due to frequent network outage. The specific annual amount of energy produced is 1747kWh/kW_p, and the daily average value of reference yield, arrays yield, and final yield per year are estimated to be 5.66 kWh/kW_p, 4.92 kWh/kW_p, and 4.78 kWh/kW_p respectively.

Variation of array efficiency, system efficiency, and BOS efficiency is shown in Fig. 7. The array efficiency is over 12% in all of the months. The high array efficiency is for cool months in autumn and winter, and the low efficiency is for hot months

in summer. The maximum array efficiency on December 26, 2017, is at 17.01%. BOS efficiency varies between 91% and 97.6%, with the highest and lowest BOS efficiency in January and May, respectively. The BOS efficiency highest value was on February 14, 2018, at 97.7%. The system efficiency is a range of 12% to 14.6%. The highest system efficiency was recorded on December 26, 2017, at 16.37%.

4.2. Evaluating system outages

In addition to weather condition and inherent loss of PV arrays and other PVPP components which reduce captured energy, system component outage will terminate the whole available energy and needs special attention. These outages are due to malfunction of the system components (like inverter, transformer, switch, and etc.), grid outage, and forced shut down of the plant for repair and maintenance purposes. The system component outage rate is a function

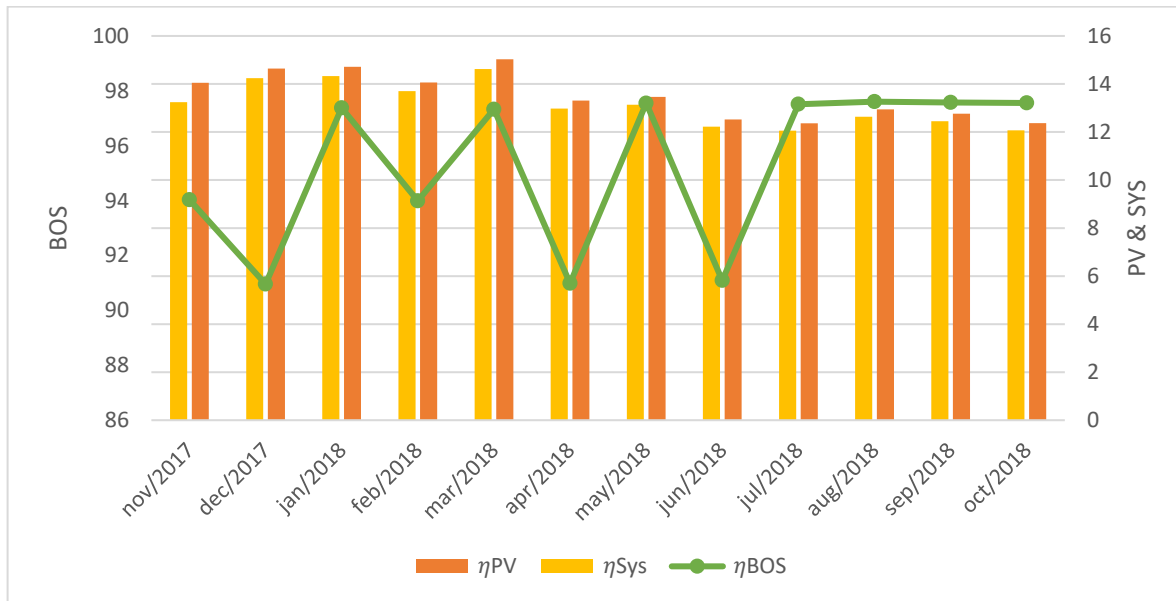

Fig. 7. Monthly average efficiencies: PV module, system, and BOS

Table 1. Monthly wasted energy.

month	Network Failure (kWh)	System Failure (kWh)	Inaccurate Operation (kWh)	Total (kWh)
Oct/2018	14610	0	0	14610
Sep/2018	0	0	0	0
Aug/2018	0	0	4170	4170
July/2018	1575	5200	0	6775
Jun/2018	0	0	12400	12400
may/2018	2300	1300	0	3600
Apr/2018	0	0	9125	9125
Mar/2018		70	54754	54754
Feb/2018	4100	0	200	4300
Jan/2018	0	0	0	
Dec/2017	2200	0	330	2530
Nov/2017	460	4690	0	5150

of their quality and lifetime usually, have a small portion of outages (in our case it is 11260 kWh/year). But distribution system outages can be more because of external fault (like short-circuit, lightning, network maintenance, and etc.) faced with along the feeder which usually has a long length (in our case it is 25245 kWh/year). In the plant under study, there was a problem that because of the lack of an automation system, after network outage and maintenance an operator should reconnect the plant. In some months this inaccurate operation caused huge energy loss because of operator laches, which is mostly due to the fact that it is the first MW power plant in Iran and there is no experience in the PVPP management (in

our case it is 80979 kWh/year). Table 1 shows the monthly energy losses from November 2017 to November 2018 due to system failure, network failure, and inaccurate operation. It can be seen that in March there is 54754 kWh lost energy. If the same energy were transmitted to the grid, it would earn income to the generating company and can be invested in the automation system.

4.3. Evaluating weather effect

The weather condition effect on the PV system consists of the level of irradiance and ambient temperature. In summer irradiance is high but the hot temperature causes

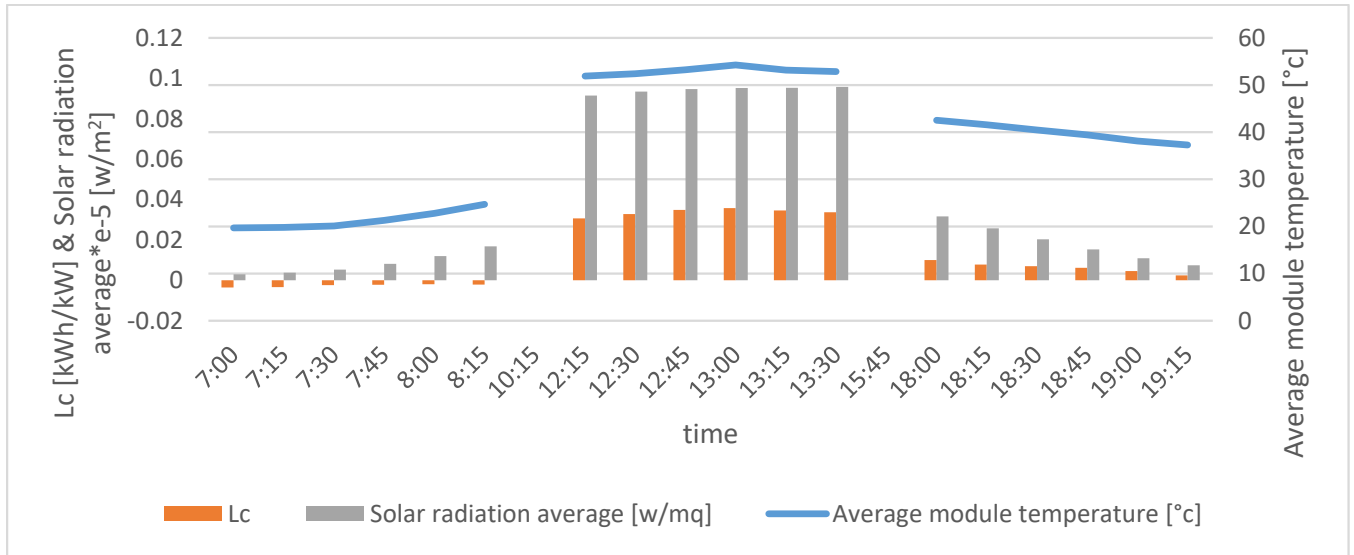

(a)

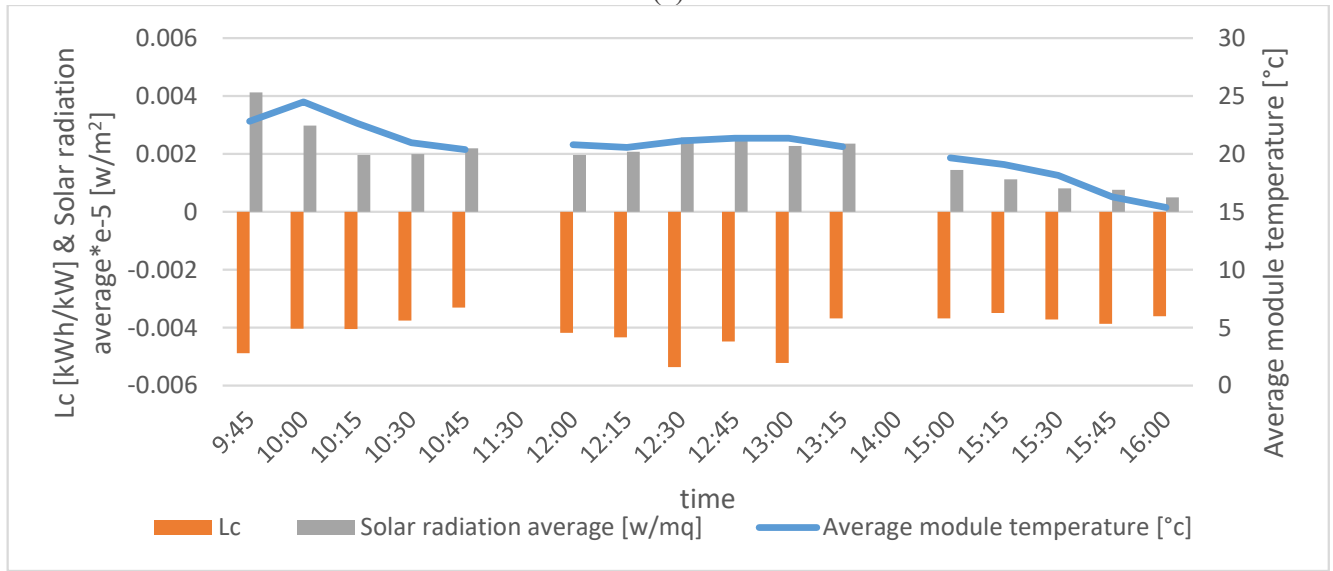

(b)

Fig. 8. Capture loss, solar radiation and module temperature in (a) summer day & (b) winter day

a high level of loss. In the other hand in winter where the temperature and loss level are low the amount of irradiance is low. The temperature of the modules depends on, the type of PV cells, type of mounting, wind speed, ambient air temperature. PV array output is not the same for the same solar radiation, before noon and afternoon, due to differences in PV module operating temperatures. To evaluate the effect of weather condition on the case study, two different days in summer and winter is considered and array capture loss is calculated for each day separately. In Fig. 8-a temperature of the modules, array capture loss, and amount of radiation at a typical summer day (06/25/2018) from 7:00 to 8:15, 12:15 to 13:30, and from 18 to 19:15 is shown. The array capture loss during the morning is negative because the temperature is lower than 25 °C. Around the noon from 12:15 to 13:30,

the solar radiation is between 914 W/m² and 957 W/m² and the modules temperature is logged at 51.9 °C to 54.3 °C. The array capture loss was obtained at this time interval of 202 kWh. Solar irradiation, PV array output, and array capture loss throw down in the evening. The total array capture losses on the selected day was 0.817 kWh/kW_p, which is equal to 817 kWh.

Similarly, on a day in the winter season (01/01/2018), array capture losses, module temperature, and solar radiation are shown in Fig. 8-b. The temperature of the module is between 20.5 °C and 21.4 °C during 12:00 and 13:15. The total array capture loss on the selected day is -0.121 kWh/kW_p. The amount of loss is negative, which means, the generation of arrays is higher than the generation at temperatures of 25 °C. The increase in generation due to the low modulus

Table 2. Comparison of performance of grid-connected PV systems.

Location	P_0 kWp	PR	Final Yield [kWh/(kWp*day)]	Energy kWh/kW _p	Year	reference
India	3056	0.7	3.73	1372	2011	[14]
Nouakchott-Mauritania	955	0.68	4.27	-	2015	[15]
Jae's University	68	0.58	2.32	-	2003	[36]
island of Crete	171	0.67	-	1336	2007	[17]
southern Italy	960	0.84	3.8	-	2012-2015	[37]
Ramagundam, India	10000	0.77	4.48	1634	2015	[13]
Arak, Iran	1000	0.85	4.78	1747	2018	Present study

temperature on this day is equal to 12 kWh.

4.4. Performance comparison

As mentioned before, the performance evaluation of several PVPP around the world in different geographical sites has been done. The energy, losses, and performance of plant depending on the environmental condition of the site. A comparison between Arak PVPP and several plants around the world annual performance is done in Table 2 as it can be seen Arak and, in general, the country of Iran has good potential for the construction of the solar power plant.

5. CONCLUSION

For future investment on PVPP in an area, accurate performance analysis based on real monitored data and operating experience of existing plants is essential. This paper deals with performance analysis of the first Iranian large scale grid connected PVPP for its first year of operation from November 2017 to November 2018. The performance ratio in March was 0.65 due to inappropriate operation of the system. In the rest of the months, the performance ratio average is 0.87 which is very good in comparison with other existing plants around the world. The parameters of average reference, array, and final yield for the mentioned period calculated as 5.66 [kWh/(kWp-day)], 4.92 [kWh/(kWp-day)], and 4.78 [kWh/(kWp-day)] respectively. In the event of proper operation of the system, the capacity factor would increase by 1.3%, which would increase the injection energy to the grid by an amount of 117.848 MWh. Comparison of the plant with some plants around the world shows a big potential of photovoltaic energy in Arak. To decrease lost energy due to system operation, solutions are suggested as follows.

- Establish the automation system on power plant and grid to re-connect the power plant to the grid in failure situations
- Connect the PVPP to the sub-transmission substation via a direct feeder
- Use change-over switch to change the feeder when

performing repairs on the feeder

6. ACKNOWLEDGMENTS

This article was done with the financial support of the project approved by Markazi Province Electric Distribution Company. The authors kindly acknowledge Mr. Eng. Ali Akbar Basiri and Mrs. Maryam Shoeibi for their kind co-operation in doing this work and Arak 1 MW PV power plant company for providing data.

7. LIST OF SYMBOLS

Symbol	Parameter	Unit
P_0	Nominal power	W or kW
P_p	Installed power	kW _p or MW _p
A_a	Overall array area	m ²
$G_{i,ref}$	STC reference in plan irradiance = 1000 (STC: Standard Test Condition: air mass: 1.5, temperature: 25°C)	W/m ²
G_i	Solar irradiation	W/m ² or kW/m ²
T_m	Module temperature	°C
P_A	PV array power	kW
P_{out}	Power to utility grid	kW
H_i	In-plane irradiance energy	kWh/m ²
E_A	PV array output energy	kWh
E_{OUT}	Energy output from PV system	kWh
Y_A	Spec. PV array energy yield	kWh/kWp
Y_f	Spec. Spec. Final system yield	kWh/kWp
Y_r	Spec. Reference yield	kWh/kWp

L_C	Spec. Array capture loss	kWh/kWp
L_{BOS}	Spec. Balance of system (BOS) loss	kWh/kWp
PR	Performance ratio	- or %
CF	Capacity factor	%
η_A	Array efficiency	- or %
η_f	System efficiency	- or %
η_{BOS}	BOS efficiency	- or %
λ	Temperature coefficient of power = -0.41	% per °C

REFERENCES

[1] A.A. Ghadimi, F. Razavi, B. Mohammadian, Determining optimum location and capacity for micro hydropower plants in Lorestan province in Iran, *Renewable and Sustainable Energy Reviews*, 15(8) (2011) 4125-4131

[2] K.G. Firouzjah, Assessment of small-scale solar PV systems in Iran: Regions priority, potentials and financial feasibility, *Renewable and Sustainable Energy Reviews*, 94 (2018) 267-274.

[3] K. Mohammadi, M. Naderi, M. Saghaifar, Economic feasibility of developing grid-connected photovoltaic plants in the southern coast of Iran, *Energy*, 156 (2018) 17-31.

[4] L.M. Ayompe, A. Duffy, S.J. McCormack, M. Conlon, Measured performance of a 1.72kW rooftop grid connected photovoltaic system in Ireland, *Energy Conversion and Management*, 52(2) (2011) 816-825.

[5] M.S. Adaramola, Techno-economic analysis of a 2.1kW rooftop photovoltaic-grid-tied system based on actual performance, *Energy Conversion and Management*, 101 (2015) 85-93.

[6] M.S. Adaramola, E.E.T. Vågnes, Preliminary assessment of a small-scale rooftop PV-grid tied in Norwegian climatic conditions, *Energy Conversion and Management*, 90 (2015) 458-465.

[7] A. Al-Otaibi, A. Al-Qattan, F. Fairouz, A. Al-Mulla, Performance evaluation of photovoltaic systems on Kuwaiti schools' rooftop, *Energy Conversion and Management*, 95 (2015) 110-119.

[8] K. Attari, A. Elyaakoubi, A. Asselman, Performance analysis and investigation of a grid-connected photovoltaic installation in Morocco, *Energy Reports*, 2 (2016) 261-266.

[9] R. Sharma, S. Goel, Performance analysis of a 11.2 kWp roof top grid-connected PV system in Eastern India, *Energy Reports*, 3 (2017) 76-84.

[10] S.K. Yadav, U. Bajpai, Performance evaluation of a rooftop solar photovoltaic power plant in Northern India, *Energy for Sustainable Development*, 43 (2018) 130-138.

[11] D. Okello, E.E. van Dyk, F.J. Vorster, Analysis of measured and simulated performance data of a 3.2kWp grid-connected PV system in Port Elizabeth, South Africa, *Energy Conversion and Management*, 100 (2015) 10-15.

[12] S. Sundaram, J.S.C. Babu, Performance evaluation and validation of 5MWp grid connected solar photovoltaic plant in South India, *Energy Conversion and Management*, 100 (2015) 429-439.

[13] B. Shiva Kumar, K. Sudhakar, Performance evaluation of 10 MW grid connected solar photovoltaic power plant in India, *Energy Reports*, 1 (2015) 184-192.

[14] K. Padmavathi, S.A. Daniel, Performance analysis of a 3MWp grid connected solar photovoltaic power plant in India, *Energy for Sustainable Development*, 17(6) (2013) 615-625.

[15] C.E.B. Elhadj Sidi, M.L. Ndiaye, M. El Bah, A. Mbodji, A. Ndiaye, P.A. Ndiaye, Performance analysis of the first large-scale (15MWp) grid-connected photovoltaic plant in Mauritania, *Energy Conversion and Management*, 119 (2016) 411-421.

[16] S. Goel, R. Sharma, Performance evaluation of stand alone, grid connected and hybrid renewable energy systems for rural application: A comparative review, *Renewable and Sustainable Energy Reviews*, 78 (2017) 1378-1389.

[17] E. Kymakis, S. Kalykakis, T.M. Papazoglou, Performance analysis of a grid connected photovoltaic park on the island of Crete, *Energy Conversion and Management*, 50(3) (2009) 433-438.

[18] P.M. Congedo, M. Malvoni, M. Mele, M.G. De Giorgi, Performance measurements of monocrystalline silicon PV modules in South-eastern Italy, *Energy Conversion and Management*, 68 (2013) 1-10.

[19] D. Micheli, S. Alessandrini, R. Radu, I. Casula, Analysis of the outdoor performance and efficiency of two grid connected photovoltaic systems in northern Italy, *Energy Conversion and Management*, 80 (2014) 436-445.

[20] M.M. Rahman, M. Hasanuzzaman, N.A. Rahim, Effects of various parameters on PV-module power and efficiency, *Energy Conversion and Management*, 103 (2015) 348-358.

[21] N. Savvakis, T. Tsoutsos, Performance assessment of a thin film photovoltaic system under actual Mediterranean climate conditions in the island of Crete, *Energy*, 90 (2015) 1435-1455.

[22] R. Dabou, F. Bouchafaa, A.H. Arab, A. Bouraiou, M.D. Draou, A. Neçaibia, M. Mostefaoui, Monitoring and performance analysis of grid connected photovoltaic under different climatic conditions in south Algeria, *Energy Conversion and Management*, 130 (2016) 200-206.

[23] A.M. Khalid, I. Mitra, W. Warmuth, V. Schacht, Performance ratio - Crucial parameter for grid connected PV plants, *Renewable and Sustainable Energy Reviews*, 65 (2016) 1139-1158.

[24] M. Shrivanth Vasisht, J. Srinivasan, S.K. Ramasesha, Performance of solar photovoltaic installations: Effect of seasonal variations, *Solar Energy*, 131 (2016) 39-46.

[25] J. López Prol, Regulation, profitability and diffusion of photovoltaic grid-connected systems: A comparative analysis of Germany and Spain, *Renewable and Sustainable Energy Reviews*, 91 (2018) 1170-1181.

[26] R. Faranda, M. Gualdoni, S. Leva, M. Monaco, A. Timidei, Analysis of a PV system with single-axis tracking energy production and performances, in: 2011 International Conference on Clean Electrical Power (ICCEP), 2011, pp. 130-136.

[27] A. Dolara, F. Grimaccia, S. Leva, M. Mussetta, R. Faranda, M. Gualdoni, Performance Analysis of a Single-Axis Tracking PV System, *IEEE Journal of Photovoltaics*, 2(4) (2012) 524-531.

[28] M. Suthar, G.K. Singh, R.P. Saini, Performance evaluation of sun tracking photovoltaic systems: A case study, in: Fifth International Conference on Advances in Recent Technologies in Communication and Computing (ARTCom 2013), 2013, pp. 328-335.

[29] S.N. Simelane, M.B. Ayanna, CSIR's single axis tracking solar PV plant performance analysis, in: 2017 IEEE PES PowerAfrica, 2017, pp. 479-482.

[30] Y. Gao, J. Dong, O. Isabella, R. Santbergen, H. Tan, M. Zeman, G. Zhang, Modeling and analyses of energy performances of photovoltaic greenhouses with sun-tracking functionality, *Applied Energy*, 233-234 (2019) 424-442.

[31] C. Lamnatou, B. Lecoeuvre, D. Chemisana, C. Cristofari, J.L. Canaletti, Concentrating photovoltaic/thermal system with thermal and electricity storage: CO₂e emissions and multiple environmental indicators, *Journal of Cleaner Production*, 192 (2018) 376-389.

[32] H. Chen, J. Ji, G. Pei, J. Yang, Y. Zhang, Experimental and numerical comparative investigation on a concentrating photovoltaic system, *Journal of Cleaner Production*, 174 (2018) 1288-1298.

[33] N. Xu, J. Ji, W. Sun, W. Huang, J. Li, Z. Jin, Numerical simulation and experimental validation of a high concentration photovoltaic/thermal module based on point-focus Fresnel lens, *Applied Energy*, 168 (2016) 269-281.

[34] H. Wang, M.A. Muñoz-García, G.P. Moreda, M.C. Alonso-García, Seasonal performance comparison of three grid connected photovoltaic systems based on different technologies operating under the same conditions, *Solar Energy*, 144 (2017) 798-807.

- [35] I.E. COMMISSION, IEC61724 Photovoltaic system performance (2017).
- [36] M. Drif, P.J. Pérez, J. Aguilera, G. Almonacid, P. Gomez, J. de la Casa, J.D. Aguilar, Univer Project. A grid connected photovoltaic system of 200kWp at Jaén University. Overview and performance analysis, *Solar Energy Materials and Solar Cells*, 91(8) (2007) 670-683.
- [37] M. Malvoni, A. Leggieri, G. Maggiotto, P.M. Congedo, M.G. De Giorgi, Corrigendum To Long Term Performance, Losses And Efficiency Analysis Of A 960 Kwp Photovoltaic System In The Mediterranean Climate [*Energy Conversion And Management* 145 (2017) 169-181], *Energy Conversion and Management*, 159 (2018) 413.

HOW TO CITE THIS ARTICLE

M. Pirzadi, A.A. Ghadimi, Performance evaluation of the first Iranian large-scale photovoltaic power plant, AUT J. Elec. Eng., 52(1) (2020) 19-30.

DOI: [10.22060/ej.2020.17593.5320](https://doi.org/10.22060/ej.2020.17593.5320)



